

The Siemens logo is displayed in a bold, teal, sans-serif font.

Ingenuity for life

Introducing NX 11

New development technology for a new age of innovation

Benefits

Design

- Import scanned 3D data as facets with convergent modeling
- Easily create prototypes with improved 3D printing support
- Design features the way they are machined with swept volume
- More control, easier changes, and better access to information in sketching
- Streamline concept design with NX Realize Shape and NX Layout
- Automatically convert drawing objects to 3D PMI objects
- Reduce drawing checking time with drawing compare
- More realistic visualization and rendering with Lightworks Iray+
- Easily take advantage of point cloud data by accessing it directly, rather than re-creating
- Improve flexibility by managing NX in the cloud

Summary

NX 11 delivers a robust set of new tools and significant enhancements to existing functionality. The goal is to help you design, test and manufacture your products quickly and with fewer errors than ever before. In NX 11, several tasks that previously required tedious manual rework are now automated. With convergent modeling, you can use facet geometry and solid/surface geometry in a single model. Simcenter 3D replaces NX CAE and now powers all Siemens PLM Software simulation functionality, which is also enhanced and expanded in this release. NX 11 for Manufacturing improves productivity with tools like robotics machining and hybrid additive manufacturing, which enable you to produce completely new parts with better performance, while delivering significant cost savings.

NX 11 for design productivity

Convergent modeling

Many industries use scanned 3D data as part of their design processes. If you have worked with this data in the past, you know how painful it can be to make it usable. Irregular shapes in particular require extensive reverse engineering

so that they can be used for 3D printing, mold design, analysis or other uses. Convergent modeling in NX 11 reduces the need for this rework by bringing the scanned data in as facets, so there is no need to map surfaces, create solids, or do any other manual shape creation. You can scan your data and immediately begin building supports for 3D printing, creating molds based on the shape, including it in an assembly, analyzing it, or performing any other operation that you would with CAD data. Convergent modeling represents a huge savings in time and cost and eliminates the error-prone rework phase. Whether you are designing medical devices, retail or apparel products, or utilizing clay models for styling and design, convergent modeling is a critical tool for creating facet shapes more quickly and with fewer errors than other solutions.

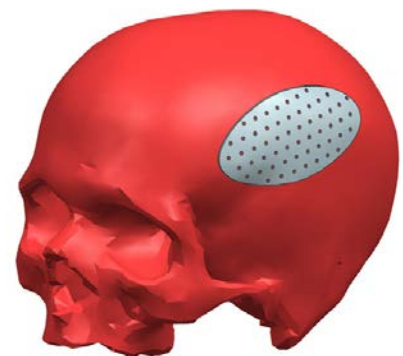

Convergent modeling can be used in the medical industry, in this case for a cranial implant.

Introducing NX 11

Benefits continued

Simulation

- Predict product performance with Simcenter 3D, now powering all Siemens simulation capabilities
- Easily create simulation reports in Microsoft Word format using a library of customizable templates
- Simulate interior and exterior acoustic analysis with Simcenter 3D acoustics modeling and simulation
- Efficiently model and simulate sections for cyclic and rotated geometry
- Understand how manufacturing processes affect structural integrity
- Predict the ultimate load capacity of systems made from composites with new material models
- Co-simulate mechanisms with controls models designed in LMS Imagine.Lab Amesim
- Simulate vehicle behavior when performing maneuvers with different road surface conditions
- Quickly create fluid domain geometry from assembly FEM (AFEM) models
- Increase the visibility of simulation results to the broader organization with enhanced JT support of CAE data

Manufacturing

- Boost productivity and increase accuracy on the shop floor with new robotic machining in NX CAM
- Create new classes of metal parts by combining additive and CNC machining in a single environment
- Use scanned cloud data of the physical plant to design/modify production lines in Line Designer
- Machine high-quality molds and dies with cutting strategies optimized for each region of the part
- Reduce programming time of prismatic parts by 60 percent with new hole making capabilities
- Precisely control complex 5-axis machining with new visualization capabilities
- Create complete work instructions as you program the job
- Deliver NC work packages under revision control from NX CAM to the shop floor using DNC Connect
- Accelerate CMM inspection by three times with new high-speed measurement cycles
- Easily manage BOMs of mold/die assemblies using new flexible spreadsheet display

3D printing

NX 11 has the strongest 3D printing support yet. In addition to convergent modeling, you can 3D print your designs directly from NX by using File>3D Print. Since this functionality uses the 3D printing toolkit offered with Microsoft® Windows® and the widely supported 3D Manufacturing Format (3MF), you can rely on wide compatibility.

Feature modeling

Parametric solid modeling is the foundation of modern 3D design. NX 11 builds on this foundation with tools like swept volume, which enables you to create design features the same way they are created with machining processes - by sweeping a solid body along a 2D or 3D path. A simple new tool for

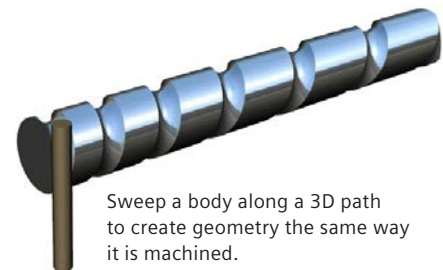

creating an associative bounding volume is particularly useful for tooling and fixture design. New options for interrupting and renewing feature builds give you more control over the model and make it easier to take advantage of legacy data. Hole creation functionality is improved with emphasis on threads and depth settings. Selecting what you need in the context of your work is easier than ever, too.

Surfacing

Surface modeling remains a vital tool in most industries, particularly for industrial design and styling. NX 11 reinforces a strong surfacing tool set with new and refined functionality. With curve scaling, you can create scaled copies of curves, part edges or points as a new feature with the option

to make it associative to the original. You can now flatten a curved surface, make changes to it and re-form it to its original shape, giving you more control to use the workflow you want. Sheet trimming is faster and easier because sheets need not extend past the cutting object. With variable offset faces in NX 11, you can create a body with constant and variable thickness in one operation, which is particularly useful for light-weighting. Finally, variational sweeping is improved to make it easier to create complex shapes in fewer steps.

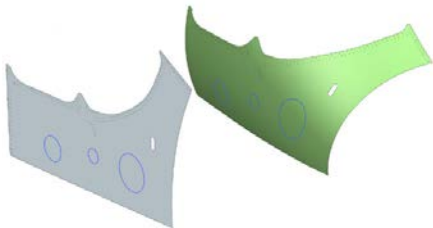

Flatten, modify, and re-form curved surfaces in NX 11.

Sheet metal design

Sheet metal design in NX is also improved. You no longer need a separate aerospace sheet metal license to access these commands and functionality. In NX 11, the commands have been rewritten, improved and incorporated into NX Advanced Sheet Metal.

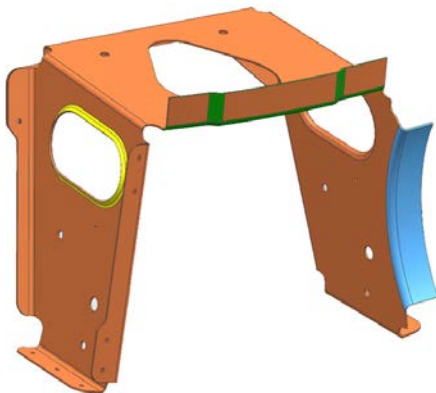

Create the geometry you need in fewer steps with sheet metal design functions of NX 11.

Advanced flange creation is now part of the base sheet metal architecture, improving reliability and compatibility with other sheet metal commands.

You can create more complex joggles with new support for intermediate web faces and adjacent web faces. Enhancements to other functions such as lightening cutouts, solid punches, bridge bends, beads and dimples, normal cutouts, and contour flanges help you create the geometry you need in fewer steps with more versatility and control. From NX 11, bridge bends are available to all users within the standard sheet metal license.

Synchronous technology

Giving you the ability to work on any model, regardless of origin, as well as the ability to add intelligence to dumb data, synchronous technology in NX leads the industry. Incremental improvements in NX 11 include the ability to replace a face with another that includes open edges. You can now delete faces to split a single body into multiple bodies. Finally, automatic face selection makes it easier to optimize faces.

Sketching

Designers spend a great deal of time creating and modifying the sketches that drive geometry. In NX 11, the sketcher has a number of enhancements that give you more control and

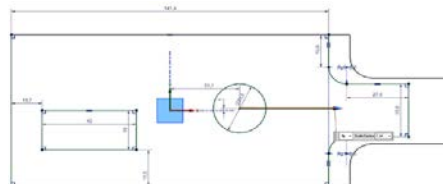

Scale entire sketches or portions of sketches in one step.

make it easier to make changes and find the information you need. For example, you can now decide whether to display automatic dimensions, so you can make your screen less cluttered while still retaining the benefits of auto-dimensioning. When you move geometry in a sketch, you get an improved visual preview of the curves you are moving, and the associated dimensions move

with the curves. It is also easier to scale sketch geometry. You have the option to scale around the sketch origin or on the first driving dimension. With the new scalable sketch group functionality, you can designate a group of features to be scaled, which is especially useful for re-usable objects that may not come in at the correct size. NX 11 also gives you more control over how sketch geometry is constrained; points and vertices on curves can now be horizontally or vertically aligned with other points and vertices, and the midpoints of lines and arcs now have selectable vertices that can be used for constraints. The new sketch relations browser is a powerful tool for investigating and debugging sketch objects. It allows you to easily find associated constraints, dimensions and external references, a significant aid in diagnosing sketch issues. Enhancements to spline creation make it easier to achieve G1 and G2 continuity. Creating sketches is easier than ever with a simplified dialog box. Finally, performance is enhanced by giving you control over various display options.

NX Realize Shape

Since its introduction in NX 9, NX Realize Shape™ has been continuously improved and refined. An intuitive subdivision design tool that uses simple shape manipulation to create high-quality B-surfaces, NX Realize Shape is easy to use and more capable than ever. In NX 11, you can split and merge bodies and use the clipboard to copy Realize Shape features such as cages or geometry. This makes it easier to re-use and share information from models. The new connect capability gives you the ability to attach subdivision bodies to geometry created outside the Realize Shape environment. It even fills in any gaps between the bodies, so you can make use of subdivision shapes in any model. You also have more control over the elements of the subdivision model with the ability to delete part of a cage

or move or copy single elements in a body. When creating a primitive shape, you can now specify the density and number of horizontal and vertical segments in the cage to get the exact shape you want. Exclusive selection simplifies the user experience by automatically deselecting the previous object when a new one is selected.

NX Layout

NX Layout is a 2D concept design tool that supports fast, intuitive concept design with full NX integration and easy adaptation to 3D. In NX 11, it is even more powerful. New functionality accelerates the creation of 2D layouts by automating the creation of 2D components from 3D parts and assemblies. By selecting a section or projection of a 3D object, you can easily create the 2D component. You can even select an assembly and preserve its structure in 2D. You also have more control over the display and hierarchy of the layout with new commands for reordering, drag-and-drop, and the ability to apply a user- or system-created order to your components. With better control, you can explore concepts in 2D more efficiently and quickly.

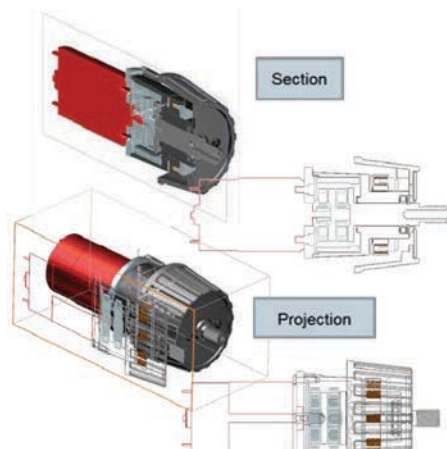

Create 2D components from 3D parts.

Working in a complex layout with many parts can be a challenge, but NX 11 has tools to make it easier. Editing in isolation enables you to work on an individual component by itself, without

the distraction of all the other components in the layout. When you need to view the full layout, the active component is highlighted in a different color while the background components retain their original colors. With the new automatic preview functionality, you can see a live preview of the component as you create or modify it to reduce the risk of errors and improve productivity. Copying components is faster and easier; you can simply press the CTRL key and drag a component to make a copy. NX Layout also delivers improved functionality with non-native 2D data, enabling you to import “blocks” of data as re-usable NX 2D components.

PMI and annotation

More and more companies are now taking advantage of Product and Manufacturing Information (PMI) to support their model-based definition (MBD) strategies. Leveraging PMI for downstream use in design and manufacturing, better quality control and faster access to critical product information provides significant benefits over traditional drawing-based processes. Many companies also tend to have large amounts of legacy 2D drawings, and to leverage this legacy data they must deal with the effort of recreating information from a drawing in the 3D model. This process can be time-consuming and must be manually verified to insure that relevant 3D information matches the information from the drawing. Using NX 11, you automatically convert drawing views and objects to model views and PMI objects. These objects include dimensions, geometric dimensioning and tolerancing (GD&T), notes and more. It is highly customizable, with options for drawings, sheets, views and annotation objects. Converting to PMI can be performed interactively or via an automated batch process. NX has always had a strong commitment to making legacy data useful without rework. With PMI conversion, you can use legacy NX drawings to add intelligence to 3D models quickly and easily.



Automatically convert drawing views and objects to model views and PMI objects.

With user interface (UI) and functional enhancements in NX 11, it is now faster and easier to generate dimensions. You can designate a secondary depth dimension for a hole callout to specify a hole or thread depth. You can also associate PMI dimensions to routed systems objects for improved interoperability. Improvements to sectioning and creating supplemental geometry provide greater flexibility for many common workflows. For companies that continue to produce drawings, a new derived section line type makes it easy to create section lines that are associative to PMI cutting plane symbols found on the model. These enhancements and others are designed to improve productivity in annotating models and leveraging them in downstream processes.

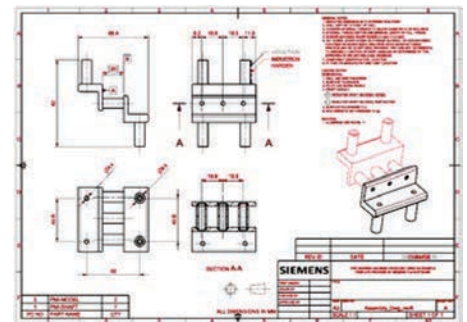

Reduce checking time with drawing comparison tools.

Drawings remain an important part of the design process for many companies, and NX Drafting remains a state-of-the-art tool for creating and maintaining them. In NX 11, smart lightweight views can take advantage of multithreaded processing to save time when working

with large assembly views. The new drawing comparison toolset dramatically reduces drawing checking time by quickly and easily identifying changes, and helps eliminate manufacturing errors that may result from drawing changes. Using NX 11, you can also display multiple assembly arrangements on a drawing to provide more information about how the product is assembled, and to show internal details or alternative builds. The arrangement views can also be edited inside NX Drafting. NX 11 adds more settings to support a number of drafting standards and simplify the creation of standards-compliant drawings.

Teamcenter integration and Active Workspace

NX and Teamcenter are better integrated in NX 11. It is easier for suppliers and OEMs to work together; OEMs can export attribute templates, enabling suppliers to use their customers' attributes for better communication and fewer errors. Intelligent save automates decisions about how to save multiple modified parts in one session in a single dialog. Internal property names are now displayed to provide clarity when there is more than one property with one name.

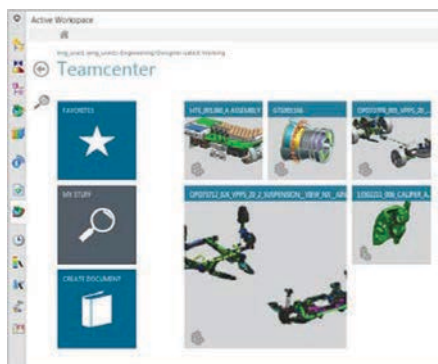

Active Workspace in NX gives you easy access to critical product information.

NX users have had easy access to a broad range of PLM capabilities for several releases thanks to Active Workspace. This embedded client makes it easier to implement a complete PLM

strategy by lowering barriers to entry. With mobile access, no separate license and no need for installation, Active Workspace enables any CAD user to see their critical product information anywhere. In NX 11, Active Workspace is faster than ever. New capabilities such as the ability to drag and drop parts to NX enable you to easily open or add parts to an assembly directly from Active Workspace. There is no need to open a separate application to access workflows such as release and change processes; in NX 11 you can access them directly from within NX. You can select multiple objects in Active Workspace and they will be selected in NX, and vice versa. It is easier to investigate interpart relationships by opening the NX Relations Browser directly in Active Workspace. With easy access to the most important information about your product, you can make better decisions faster.

High-performance rendering

Knowing what your product will look like before you make it is a great advantage in any industry. Photorealistic rendering helps you make decisions



Photorealistic rendering shows you what your product will look like before you make it.

about aesthetics, function and materials early on, when those decisions are less costly. NX 11 extends visualization capabilities with the new Lightworks Iray[®]+ rendering engine. Fully integrated into NX Ray Traced Studio, the

Lightworks Iray+ engine boasts a large library of materials and scenes, and is multithreaded to take advantage of modern microprocessors and GPUs. If you need results even faster, you can utilize other computers to assist with the heavy work of rendering. It's also progressive, meaning that it will continue to improve the quality of the image indefinitely, giving you more control over rendering completion. With the Lightworks Iray+ rendering engine, NX Ray Traced Studio is easier to use than ever, helping you to make product decisions faster.

Point cloud processing

Point cloud data is used in many industries to capture the as-is status of products, factories, plants, buildings and infrastructure objects. NX 11 introduces point-cloud processing using Bentley[®] Pointools[™]. Now you can import cloud point data in the standard POD file format, make simple measurements and perform editing functions such as show/hide, transforming, deleting, and editing of parameters. This makes it easier to access reference data, particularly for applications including plant and line design, without needing to create 3D data.



Point cloud data makes line design easier and more accurate.

Usability

NX gets faster, more efficient and easier to use with every release. In NX 11, switching between windows is fast and intuitive with CTRL-Tab and a window with thumbnails of all active parts. In addition, parts now open in the NX application they were last saved in. The detailed part information you need is

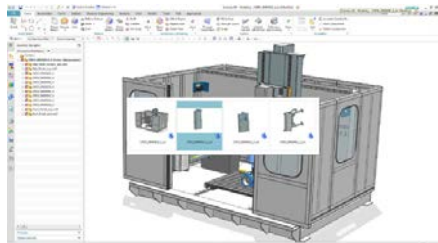

Ctrl-Tab window switching saves time and clicks.

now much easier to read and navigate with HTML information windows. Improved touch functionality and 4K monitor support all contribute to making NX easier to use so you can get the job done faster.

NX on the cloud

For some configurations of NX 11, you have the option of deploying and running NX in a cloud-managed environment. This enables you to take advantage of new NX features while also gaining many of the benefits offered by cloud-based offerings, such as reduced complexity, time, cost and risk involved in installation, maintenance and upgrades. It also means that NX will still perform and respond as you are accustomed to. Additionally, your IT team can focus on core business functions instead of managing the environment. NX on the cloud gives you flexibility, scalability and reliability that helps you match business demands as they change.

NX 11 for Simulation productivity

Introducing Simcenter 3D for simulation

Simcenter 3D replaces NX CAE and now powers all of Siemens' simulation capabilities for predicting product performance. Simcenter 3D delivers a unified, scalable and open environment for 3D CAE with connections to design, 1D simulation, test and data management. Simcenter 3D speeds the simulation process by combining best-in-class geometry editing, associative simulation modeling and multidiscipline

solutions embedded with industry expertise. Fast and accurate solvers power structural, acoustics, flow, thermal, motion and composites analyses, as well as optimization and multiphysics simulation. If you are an existing NX CAE user, you will not experience any changes to the user experience or workflows in Simcenter 3D.

Additionally, all automation routines you may have created will continue to work just as they did before.

The initial release of Simcenter 3D includes all of the capabilities of NX CAE along with many new capabilities that are highlighted in the following sections.



Simcenter 3D combines best-in-class analysis modeling and multidiscipline solutions in a single environment.

Engineering desktop (pre/post)

The Simcenter Engineering Desktop forms the hub of Simcenter 3D and represents the environment in which you conduct all of your pre- and post-processing for each of the different simulation solutions or external solvers. What was called "Advanced Simulation" in the user interface is now called "Pre/Post." Simcenter 3D introduces new capabilities in this release for report writing and general pre/post process improvements.

Report writer

You can now create reports of simulation results and finite element model data in Microsoft Word format using a

Example report format

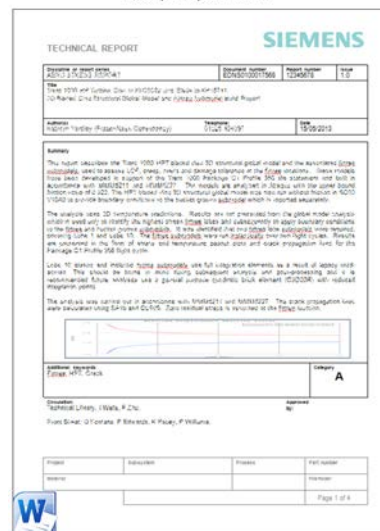

Automate and standardize simulation reports into Microsoft Word format.

library of templates that define the required information for a specific type of report and its formatting. You can modify existing templates or create your own template for your organization. These templates can then be easily distributed to your simulation team so that members can create standardized reports for their analysis results. The report writer is flexible to handle a broad range of applications, results and industry standards.

Acoustics

Are your customers expecting quieter products? Are competitors gaining ground by using sound quality as a differentiator? Will tighter noise regulations impact your product sales? Simcenter 3D introduces a completely new solution domain for acoustics that can help you conquer these challenges. Simcenter 3D offers interior and exterior acoustic analysis within an integrated solution that helps you make informed decisions during the early design stages so you can optimize your product's acoustic performance. In addition to the finite element and boundary element acoustics solutions now available in Simcenter 3D, you also

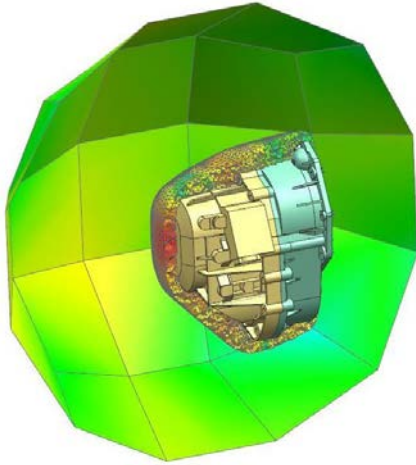

Simulate exterior noise radiation.

have access to best-in-class acoustics modeling capabilities that can help you perform your entire acoustics simulation workflow faster than ever. You can take advantage of Simcenter 3D's platform benefits that also include analysis modeling tools unique to acoustics simulation, such as creating the fluid domain geometry or a convex mesh. Simcenter's powerful geometry and analysis modeling capabilities can accelerate these once cumbersome and tedious tasks.

Multiphysics

Cyclic symmetry

Cyclic symmetry is now available in Simcenter 3D for multiphysics (coupled thermal-structural), thermal and structural solutions. The new simulation object automates the process of defining cyclic symmetric boundary coupling between incompatible surfaces to help streamline the process of defining 3D cyclic symmetry analyses. You can define boundary coupling by either manually defining region pairs or using the software to automatically determine them. This capability can be used to more efficiently model only a single sector of a more complex 3D system that has cyclic symmetry, often characteristic of rotating machinery applications like gas turbines and aircraft engines.

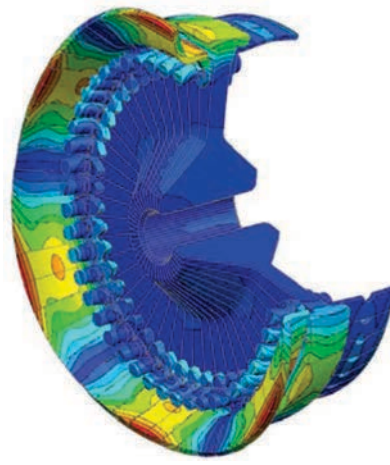

Simply model a single section of a cyclic symmetric part, and then view results over multiple sectors.

Fourier modal

Beginning in this release of Simcenter 3D, you can include a new axisymmetric Fourier modes step in your solution to perform axisymmetric Fourier harmonics analyses. The software computes the modes about the nonlinear stress or displacement state at the end of a previous static step in the solution. In a standard axisymmetric analysis, the

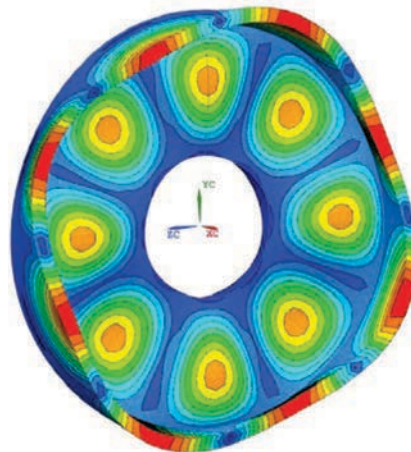

Predict non-linear static deformations and any order modes for axisymmetric models.

software calculates a subset of the 3D modes. In an axisymmetric Fourier analysis, the software computes all the modes for a 3D structure. Ultimately this enables you to model a simple 2D cross section of 3D geometry to

efficiently model systems with axisymmetric geometry such as industrial tanks, aero engine seals or gas turbine rotatives. Fourier analysis is supported in Simcenter 3D's multiphysics (coupled thermal-structural) and structural solutions.

Structures

Manufacturing simulation

In this release, you can now predict the stresses and deformations from a series of manufacturing steps, such as bolt tightening, load sequencing, component addition and bolt removal. This type of analysis is often used to simulate the effect from assembly of auto powertrain systems, aero engine casings and industrial machinery. Manufacturing simulation in Simcenter 3D is the result of a number of enhancements in this release, including bolt load sequencing and the ability to add or remove contact regions and friction by subcases, including contact stiffness and more.

Initial stress/strain

During manufacturing operations such as forging, residual stresses can occur and reside within your end product. These residual stresses and strains can ultimately impact the life of your product. In Simcenter 3D, you can now include the effect of residual stress or strain in a stress simulation to help you to make more accurate life predictions of your end products or components.

Composites

Composite failure

New enhancements in Simcenter 3D, such as new delamination and ortho-

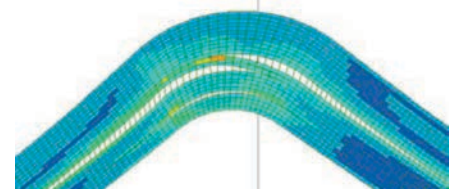

Predict ultimate load capacity of systems made from composite laminates.

tropic damage material models and progressive ply failure, allow you to predict ultimate load capacity of systems made from laminate composite materials. Composite failure modeling can be used in applications for airframe and aircraft engine components, spacecraft, automotive components and even sporting equipment.

Motion

New Simcenter 3D motion solver

Simcenter 3D uses a new motion solver, the same solver that was used in LMS Virtual.Lab™ Motion software. The new Simcenter motion solver provides you with all of the required basic dynamic motion capabilities for realistic multi-body simulation and analysis. Among the benefits of the new solver are improved 3D contact. In addition to the new solver, you can capture Simcenter 3D results in a named expression using results measures. This capability enables you to validate motion results against a predefined condition, change model parameters and optimize the model.

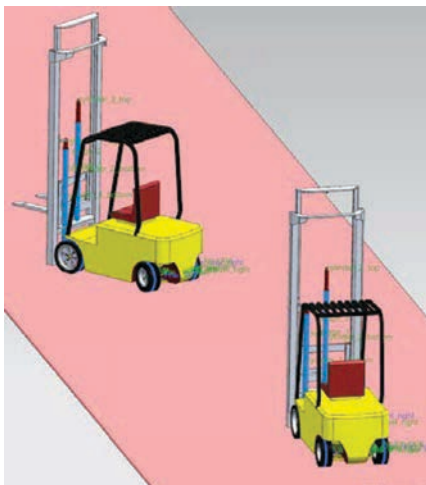

Conduct realistic multibody simulation and analysis with improved 3D contact.

Co-simulation with Imagine.Lab Amesim

Controls engineers need good models of the mechanical system in order to test their control algorithms. Conversely, mechanical engineers need the ability to simulate the motion of their mechanisms with controllers. As part of the Simcenter portfolio, Simcenter 3D is able to link with tools used in the broader development process, like 1D system simulation. For motion simulation, Simcenter Motion has the ability to co-simulate motion models with 1D control systems developed with LMS Imagine.Lab™ Amesim software.

Tires and roads

With Simcenter 3D, you can predict how vehicles behave when performing different maneuvers with different road surface conditions. Simulating the tire behavior can help you optimize the performance of cars and other types of vehicles in terms of driving dynamics (ride comfort and handling) as well as durability. After solving the mechanism, you can view an animation or articulation of the tire's behavior, and plot how much force or torque is applied to the tire and chassis, the size of any slips and so on. You can then use this information to make any appropriate adjustments to the vehicle design.

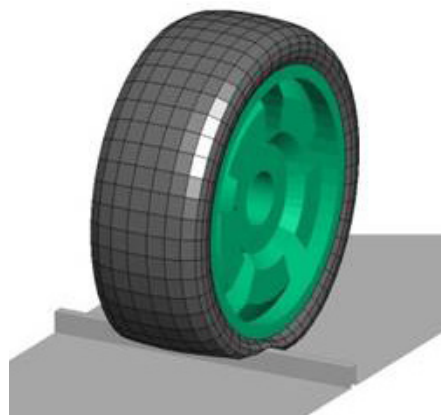

Model tire forces acting between rotating wheels and the road.

Flow

Surface wrapping enhancements

Surface wrapping in Simcenter 3D helps you rapidly create fluid domain geometry from a complex geometry part. This release of Simcenter 3D further enhances the surface wrapping capabilities in a number of ways. First, you can now use surface wrapping on an assembly FEM (AFEM). Previously it was only possible to use surface wrapping for components when used on a mesh. Using a surface wrap on an AFEM improves your modeling efficiency and helps you to create a fluid domain of a complex part when you don't have the underlying geometry available. Another enhancement to surface wrapping is the new auto refinement constraint. The auto refinement constraint for the wrapping algorithm ensures that the software finds the optimal local resolution required to capture the smaller bodies and ultimately give you the definition you need where you need it in the model.

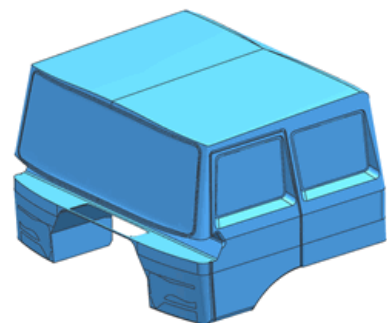
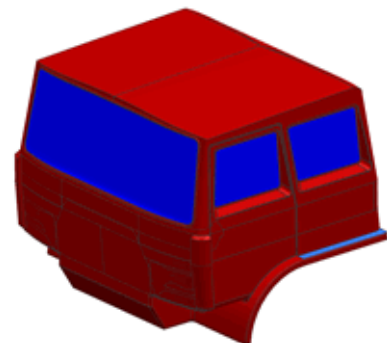

Surface wrapping auto refinement gives you the definition you need where you need it for the fluid domain geometry.

Hybrid hex-tet meshing

In Simcenter 3D, you now have the ability to create a tetrahedral-hexahedral hybrid mesh of 3D solid elements on selected bodies. When creating the hybrid mesh, Simcenter will also use pyramid elements to transition from the hex mesh to the tet mesh. With a hybrid mesh, you get fewer elements, which can improve both memory usage and solver performance. In general, hybrid meshes are better suited for models with large cavities or volumes not adjacent to boundaries, where a large number of hexahedral elements can be generated.

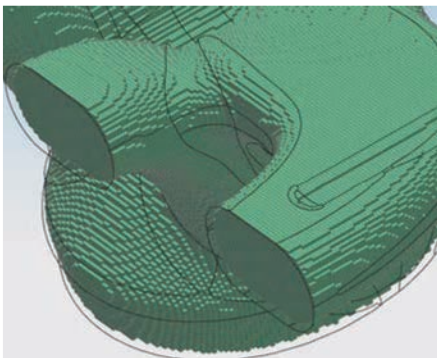

Improve memory usage and accelerate solver performance with hybrid hex-tet meshing.

Simulation data and process management

Active Workspace

Active Workspace is enhanced to support the Teamcenter simulation process management data model. Active Workspace provides a user-friendly

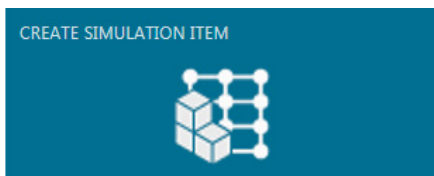

Use Active Workspace in Simcenter 3D for easy access to critical information.

front-end to working in managed mode from Simcenter 3D, and if Active Workspace is installed, it replaces the Teamcenter navigator when working in managed mode. The Active Workspace home page includes a "Create Simulation Item" tile, which you can use to create CAE-specific items.

Updated JT format to support CAE

A new JT file format to support more CAE data is available in Teamcenter visualization 11.1.2, and Simcenter 3D can export JT files in this new format. With this capability it is now possible to include multiple results within the same JT file. Additionally, users viewing the JT file will now be able to query or probe analysis results directly within in the Teamcenter visualization tools. Decision makers within the broader product development organization can look more deeply into simulation results without the need for a heavyweight CAE pre/post tool.

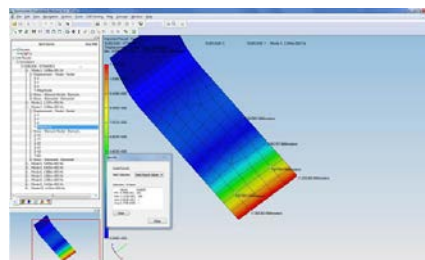

Visualize simulation results within a lightweight viewer easily accessible by the broader engineering organization.

NX 11 for Manufacturing productivity

New software technologies in NX 11 for Manufacturing can dramatically improve productivity and create new opportunities to transform your business. The robotics machining and groundbreaking hybrid additive manufacturing capabilities enable you to produce completely new parts with better performance while delivering tremendous savings. With Line Designer's point cloud updates you can design and visualize layouts of production lines more quickly and associate the production layout design to

manufacturing planning. New advanced NC programming capabilities for molds and dies, prismatic components and complex-geometry parts enable efficient programming while reducing machining cycle and improving part quality.

New, innovative technologies

Robotics machining

Robotics machining provides more flexibility and dramatically improves efficiency on the shop floor. NX CAM robotics machining helps robots to perform precise machining-type tasks that are often done manually. Automating these operations can reduce manufacturing cycle time and improve quality.

Beyond the familiar tasks of lifting, positioning and welding, robots are being fitted with tool holding heads. This enables robots to perform machining operations such as trimming, polishing and deburring to boost your productivity.

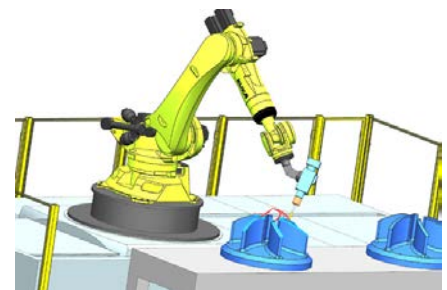

Program robots with NX CAM to expand manufacturing automation and provide more flexibility.

Improve efficiency by taking advantage of the large work envelope and flexibility of industrial robots. Robotics machining increases your flexibility to machine larger parts in a single setup and improve repeatability and accuracy by relying on the robots' precision motions.

Hybrid additive manufacturing

Hybrid manufacturing combines additive manufacturing (metal deposition) and CNC machining into a single environment to create new product designs with speed and precision. You can manufacture production-ready metal components on a single machine. NX CAM provides a complete solution to program the latest hybrid machines by DMG MORI. By building up complex geometries using additive manufacturing, including internal cavities, and then machining them for tight tolerances as they are built using subtractive manufacturing, you can manufacture new classes of parts or consolidate many setups into one.

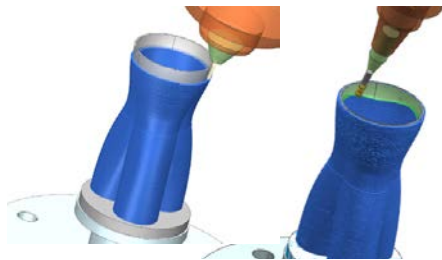

NX hybrid additive manufacturing combines 3D printing (metal deposition) and CNC machining in a single environment.

In addition, the increased speed of powder deposition methods and the flexibility of building parts in 5 axes mean that hybrid additive manufacturing is better suited to production work than ever. This development represents an industrialization of additive technology as it becomes suitable for more applications.

Line Designer

Line Designer allows you to quickly design and visualize layouts of production lines in NX. With point cloud data support, you can easily compare your physical plant with your virtual plant layout model. Using Bentley technology, point clouds scanned from

brownfield environments can be used to create new plant items or modify plant models after on-site changes. Point clouds also help to initially build 3D layouts where there is no existing CAD data.

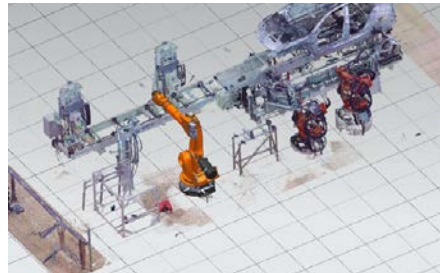

Point clouds scanned from brownfield environments are used to create new plant items in Line Designer.

For globally distributed manufacturers, keeping plant models up-to-date helps distant plants duplicate their processes and maintain consistent quality across different product sources. When the centrally located plant design office is far from the actual plants it is trying to accurately model and update, point clouds quickly convey information that would otherwise require extensive time and travel to acquire. Using point cloud scans can help keep plants working with best practices and up-to-date methods across your enterprise.

NX CAM

Mold and die machining

Powerful new computer-aided manufacturing capabilities for mold and die machining enable you to create more precise tool paths faster and produce parts with high-quality surface finish. Multithread processing takes better advantage of multi-core hardware and produces tool paths as much as 50 percent faster. Recalculations are also faster, with intelligent updates across multiple operations that understand dependencies and recalculate only what requires an update. Non-cutting moves can be quickly updated without disturbing the cutting passes, making recalculations even faster.

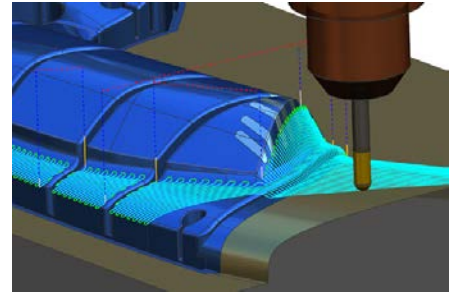

Intelligent tool path recalculation in NX CAM allows quick refinement for best results.

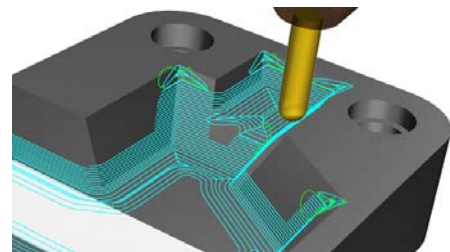

Optimized cutting strategies for different part regions improve machining efficiency and deliver superior finish.

NX is delivering quality where it counts – on the surface of the part. Smooth, consistent on-part stepovers provide fine finishes across even imperfect imported geometry. And fine finishes in corners and valleys where smaller tools are used to complete machining are achieved with careful attention to cutting directions in steep and non-keep areas. These optimized cut directions make for more consistent semi-finish results as well. Toolpath validation gives you confidence at the machine tool knowing that the toolpath is error-free. NX has a new option providing final validation results almost immediately, delivering significant time savings, especially in programming large or complex molds.

Production machining

Production machining is typified by cutting larger quantities of prismatic parts with many features, such as components used in machinery, automotive and energy industries. It is important to have advanced tools to accelerate or automate the programming of these features and, more importantly, to minimize the cycle time on the machine tool. NX 11 provides several efficiency improvements and more automation for hole making, yielding reduced cycle times and up to 60 percent faster programming.

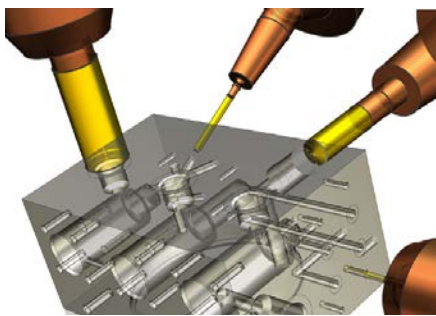

The new hole making capabilities in NX CAM can reduce programming time by up to 60 percent.

NX CAM software introduces several new operation types that make it easy to program complex, non-standard hole making processes for minimum cycle times. Deep hole drilling (gun drilling) automatically recognizes existing cross holes and speeds up the tool advance across pre-drilled channels. The new back countersinking operation positions specialized tools for an offset insertion through the hole, then turns on the spindle for back cutting. More specialized operations include chamfer milling for modeled or unmodeled chamfers and radial groove milling to provide circular passes with radial and axial steppers as needed. These non-cycle operations would be tedious and error-prone to program manually, but are now easily programmed for efficient cutting.

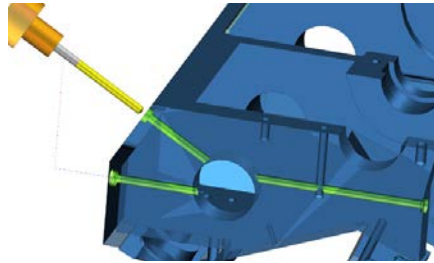

Deep hole drilling (gun drilling) automatically recognizes cross-holes to reduce cycle time.

NX CAM software makes it easy to program holes in logical groups, both manually and automatically with feature-based machining. You can maintain the most efficient cutting sequences by optimizing across hole groups to connect cuts together, minimize engages, and even re-sequence to avoid obstacles. The optimized tool-paths ensure safe cutting and reduced cycle times.

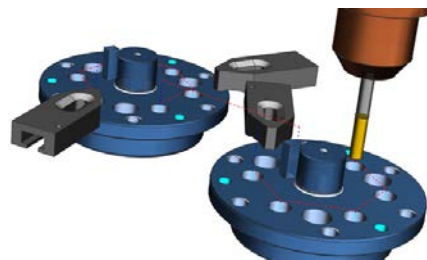

Optimized drilling sequences across hole groups ensure safe cutting and minimize engages.

Feature-based machining is a powerful method to automate NC programming time and keep programs consistent. NX makes it easier than ever to maintain and update your feature machining processes by defining feature variations and associated process variations in NX. Machining rules can be defined directly in the NX software, streamlining the development of your automated processes.

Complex parts machining

In the aerospace and medical industries particularly, 5-axis machining is critical to reaching and cutting complex shapes accurately and safely. As the tool axis

changes during the cut, it is important to precisely control the cutting process to avoid tool overloads and sudden machine rotations.

New capabilities in NX CAM software allow easy analysis of complex multi-axis machine behaviors. You can optimize the machining conditions by visualizing 5-axis tool path characteristics, including:

- Tool lead angle
- Rotary axis positions, with over-travel limits
- Rotary axis speeds to detect reversals
- Short and long segments

This visual analysis helps you verify your cutting conditions across the entire operation.

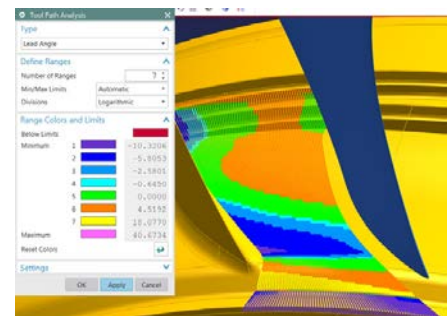

Visual analysis reveals important information about 5-axis cutting conditions.

Shop floor connectivity

The shop floor is where the benefits of NC programming are realized. NX CAM software produces complete shop floor documentation, but can also link more substantial systems for data and process management. The manufacturing resource library (MRL) provides complete tool assemblies for CAM programming. Teamcenter manages complete work packages and serves them to shop floor DNC systems, even including MRP systems.

NX CAM 11 has new capabilities for creating postprocessors directly in the NX environment, where the post's kinematic definition comes

automatically from the machine tool digital model. The new post configurator provides modular layers of output definitions that can serve as templates, making posts easier to build and maintain.

Work instructions are output files that greatly impact the productivity of shop personnel setting up new jobs. NX CAM enables you to document each step of the process with a unique setup sheet that includes the view of the setup and any instructions required. You can easily include standard instructions as selectable text templates and provide complete tool lists. Work instructions are associative and easily update to reflect geometry or toolpath changes. You can deliver work instructions as rich HTML pages with graphics, which can be displayed on the machine controller.

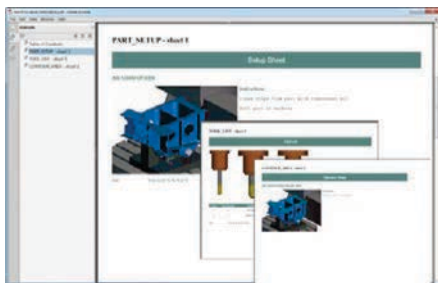

Create comprehensive and associative work instructions as you program in NX CAM.

An important new development in shop floor connectivity is the availability of managed DNC communication – even for NX CAM users that do not use the Teamcenter application. DNC Connect hands off NC work packages from NX CAM to the managed DNC system, which is based on Shop Floor Connect. The work packages are delivered to the shop floor under revision control to ensure that the correct released data is used in production.

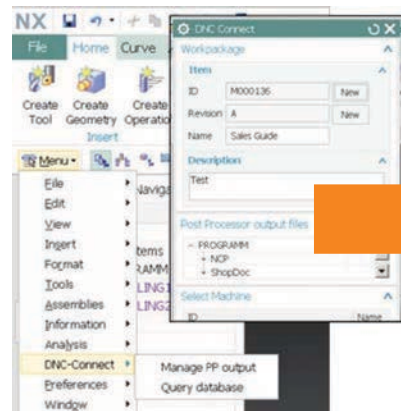

DNC Connect lets NX CAM users easily deliver work packages to the shop floor, ensuring that the correct data is used in production.

NX CMM inspection programming

Coordinate measuring machines (CMM) are key quality control features of manufacturing shops. NX CMM inspection programming can efficiently program CMM equipment and also read the results back into NX for visual comparison and analysis.

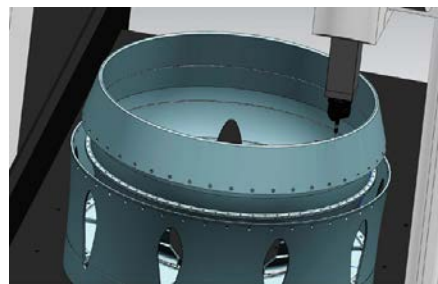

A new high-speed inspection cycle using “head touches” in NX CMM enables three times faster inspection while improving accuracy.

An important development in CMM scanning technology is the availability of high-speed heads that scan a surface and “flick” the head to make intermittent touches. In NX 11, NX CMM is able to program Renishaw PH20 probes to take advantage of their unique “head touches,” even showing the head motion in simulation. These new probes

allow measurement points to be taken faster and with improved accuracy and repeatability by moving only the probe head instead of the entire CMM structure. With NX CMM, you can easily program the latest probes, taking measurement points three times faster.

Establishing base coordinate systems and datums for measurement programs is easier with NX 11, as simple geometry selections fix the degrees of freedom until the datum is fully defined, speeding up the setup of a CMM program.

In aerospace and automotive sheet metal applications, where more traditional features are absent, CMM programs are often based on datum planes attached to surface points. NX 11 speeds up the definition of such datum planes with automatic creation of datum features that can remain associative to the Product Manufacturing Information (PMI).

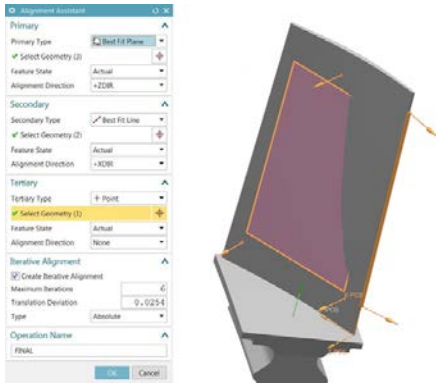

Program origins are easily constructed with quick geometry selections

Analysis of measured data in NX CMM programming is also enhanced, with graphical displays of the measured data on the part model, making it easier to understand the measurement results and monitor part quality more effectively.

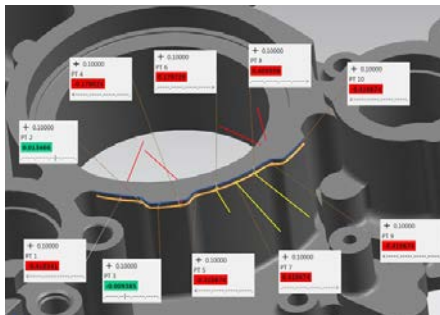

Analyze inspection results by overlaying the measured data on the 3D part model in NX CMM.

NX tooling design

NX 11 tooling design delivers increased productivity when designing molds and progressive dies. First, a flexible spreadsheet display of the Bill of Materials (BOM) makes it easier to manage, edit and update the BOM. The spreadsheet display also allows bulk edits for faster updates.

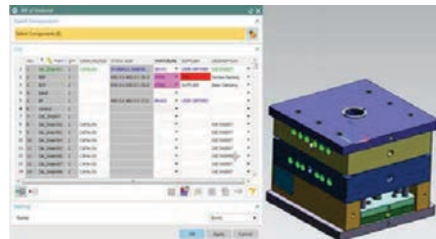

Flexible spreadsheet display of the Bill of Materials makes it easier to manage, edit and update.

Mold and die design efforts gain great efficiency by utilizing standard components and design features. Drag and drop standard components from the flexible and configurable re-use library. Standard library parts, including your custom components, are stored in the re-use library with improved search capability and family-of-parts support. Easy access to standard and custom components can significantly accelerate your tooling design.

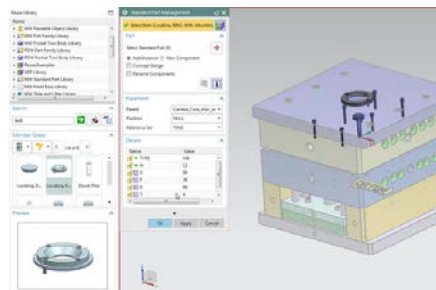

Speed up mold and die design by re-using standard and custom components from libraries.

Several standard mold design components (cooling components, ejectors, gates and runners) and die design components (forming inserts, piercing inserts) are updated with more intelligent configurations to accelerate your tooling design.

Mold and die motion visualization and validation help you verify complex motion more accurately with NX 11. You can clearly view additional component actions, including hydraulic components and the actions of sliders and lifters. Visualization and validation using the complete digital model of your tooling assembly speed up the design and prevent costly errors in production.

Siemens PLM Software
www.siemens.com/plm

Americas +1 314 264 8499
 Europe +44 (0) 1276 413200
 Asia-Pacific +852 2230 3308

© 2016 Siemens Product Lifecycle Management Software Inc. Siemens and the Siemens logo are registered trademarks of Siemens AG. D-Cubed, Femap, Fibersim, Geolus, GO PLM, I-deas, JT, NX, Parasolid, Solid Edge, Syncrofit, Teamcenter and Tecnomatix are trademarks or registered trademarks of Siemens Product Lifecycle Management Software Inc. or its subsidiaries in the United States and in other countries. All other logos, trademarks, registered trademarks or service marks belong to their respective holders.